

© lutz-blades.com



FILM BLADES MADE BY LUTZ – HIGH-PERFORMANCE BLADES FOR HIGH-PERFORMANCE FILM

CUSTOM BLADES

FILM AND FOIL

CHEMICAL FIBRES AND FIBREGLASS

MEDICAL

FOOD

DIY

AUTOMOTIVE

TEXTILES



PRECISION. SHARPNESS. SUCCESS.
exactly

Reasons why you need LUTZ BLADES:



PRECISION.

Our maxim is precision – and it is this principle that accompanies every stage from the initial idea to the finished product. Right through to the ideal solution for your specific cutting application to ensure your requirements are met. Throughout every design and development stage and every production step – blade after blade after blade.



SHARPNESS.

Your competitive advantage when you use blades from LUTZ for cutting film is the sum of all our efforts and the details we guarantee you. We are pleased to show you those details because your success is our objective – from the first to the millionth blade.

SUCCESS.

exactly

Your competitive advantage when you use blades from LUTZ for automotive cutting applications is the sum of all our efforts and the details we guarantee you. We are pleased to show you those details because your success is our objective – from the first to the millionth blade.



FILM BLADES MADE BY LUTZ – HIGH-PERFORMANCE BLADES FOR HIGH-PERFORMANCE FILM

Tough film which is also highly elastic? Additives present? Impact loads and lateral forces? There is no doubt that film manufacture is a high-performance process.

LUTZ manufactures high-grade special-purpose blades for industrial applications. We make use of a wide

range of steel qualities, tungsten carbide and ceramics.

In terms of material, heat-treatment and cutter geometry, our blades are designed specifically to meet the application needs of the user.













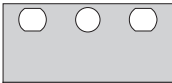
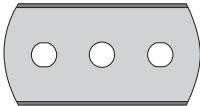
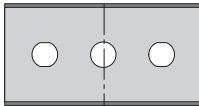



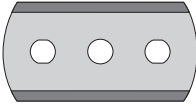

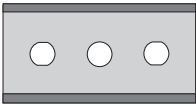

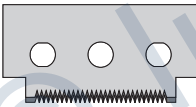

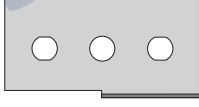

CUSTOM BLADES | FILM AND FOIL | CHEMICAL FIBRES AND FIBREGLASS | MEDICAL | FOOD | DIY | AUTOMOTIVE | TEXTILES

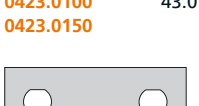
LUTZ allows access to all its website content for viewing purposes. Copying and reproducing content (copy, images etc.) for anything more than transient use is not permitted. This content may not be modified or used on other websites or networked computers without prior written approval by LUTZ GmbH & Co. KG.

Copyright: © COPYRIGHT LUTZ GmbH & Co. KG, Solingen, Germany. All rights reserved. Copy, photos, graphics, technical drawings, layouts and other information used in all our publications and their arrangements on our LUTZ website are subject to copyright and other proprietary rights.

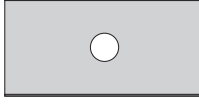
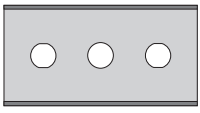
Proprietary rights: The owner of the brandnames used by LUTZ is LUTZ GmbH & Co. KG, Solingen, Germany (unless otherwise stated). Third Parties are explicitly prohibited from using any of the brandnames, logos or marks of any kind found there. This applies in particular to the internationally registered trademark symbols LUTZ, which consist of a stylized 'L' and 'Z' symbol, and all violations against trademark law regarding its trademarks.

E & OE. Brandnames marked with an asterisk (*) are not owned by LUTZ GmbH & Co. KG. Subject to our general terms & conditions on the Internet at www.lutz-blades.com.

Ref.	Length (mm)	Width (mm)	Thickn. (mm)	Ref.	Length (mm)	Width (mm)	Thickn. (mm)	Ref.	Length (mm)	Width (mm)	Thickn. (mm)
	39.0	18.8	0.30		43.0	22.2	0.06		43.0	22.2	0.10
	34.0	8.0	0.30				0.08				0.15
	43.0	22.2	0.40				0.10				0.20
	43.0	22.2	0.40				0.13				0.30
	43.0	21.5	0.30				0.15				0.40
	39.0	18.9	0.25				0.20		43.0	22.2	0.10
							0.30		43.0		0.15
							0.40		40.0	18.8	0.25
							0.65		40.0	22.0	0.10
					38.0		0.10				
							0.15				
							0.20				
							0.30				
							0.40				

AND THIS IS HOW YOU CAN BENEFIT FROM LUTZ FILM-CUTTING BLADES

- » Cleanly cut edge with no edge build-up
- » Less cutting dust
- » High cutting speeds
- » Greater productivity thanks to fewer blade changes



CUSTOM BLADES | FILM AND FOIL | CHEMICAL FIBRES AND FIBREGLASS | MEDICAL | FOOD | DIY | AUTOMOTIVE | TEXTILES



LUTZ allows access to all its website content for viewing purposes. Copying and reproducing content (copy, images etc.) for anything more than transient use is not permitted. This content may not be modified or used on other websites or networked computers without prior written approval by LUTZ GmbH & Co. KG.

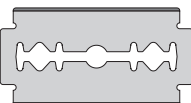
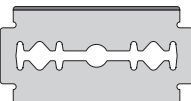
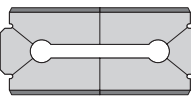
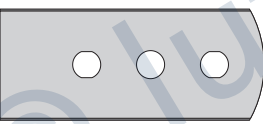
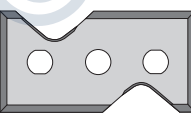

Copyright: © COPYRIGHT LUTZ GmbH & Co. KG, Solingen, Germany. All rights reserved. Copy, photos, graphics, technical drawings, layouts and other information used in all our publications and their arrangements on our LUTZ website are subject to copyright and other proprietary rights.

Proprietary rights: The owner of the brandnames used by LUTZ is LUTZ GmbH & Co. KG, Solingen, Germany (unless otherwise stated). Third Parties are explicitly prohibited from using any of the brandnames, logos or marks of any kind found there. This applies in particular to the international registration of trademarks, logos or marks of any kind which consists of words, letters, symbols, LUTZ will pursue all violations against trademark law regarding its trademarks.

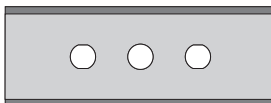
E & OE. Brandnames marked with an asterisk (*) are not owned by LUTZ GmbH & Co. KG. Subject to our general terms & conditions on the Internet at www.lutz-blades.com.

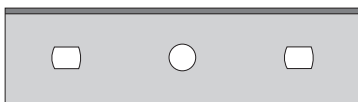
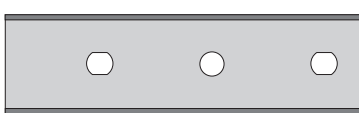
Ref.	Length (mm)	Width (mm)	Thickn. (mm)
	43.0	22.2	0.10
0420.0100			0.15
0420.0150			0.20
0420.0200			0.30
0420.0300			
	43.0	22.2	0.20
0436.0200			
	43.5	19.0	0.10
0425.0100			0.20
0428.0200			
	52.7	22.2	0.15
0520.0150			
	43.0	22.0	1.00
0470.1000			

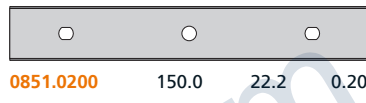
Ref.	Length (mm)	Width (mm)	Thickn. (mm)
	60.0	22.2	0.10
0600.0100			0.13
0600.0130			0.15
0600.0150			0.20
0600.0200			0.30
0600.0300			
0500.0130	50.0		0.13
0500.0150			0.15
0500.0300			0.30
	80.0	22.2	0.20
0800.0200			0.30
0800.0300			
	80.0	22.2	0.20
0810.0200			
0812.0200	100.0		
	94.0	22.2	0.30
0850.0300			

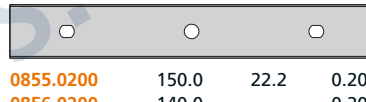
Ref.	Length (mm)	Width (mm)	Thickn. (mm)
	150.0	22.2	0.20
0851.0200			
	118.0	22.2	0.15
0852.0150			
	150.0	22.2	0.20
0855.0200			0.20
0856.0200	140.0		0.20
0857.0150	125.0		0.15

IMPROVING ON THE NEAR-PERFECT – HARD COATINGS EXTEND LIFETIMES

As a supplier of high-quality special blades, we pride ourselves on being able to offer a wide selection of coatings (TiN, TiC, TiAlN, CrN, DLC, TiCN, PTFE etc.), which are designed to extend the lifetimes of the blades considerably when cutting

white film, aluminium foil, filled LLDPE and PET film, magnetic tape, OPP and BOPP film and other types of film. We will be pleased to advise you.



CUSTOM BLADES | FILM AND FOIL | CHEMICAL FIBRES AND FIBREGLASS | MEDICAL | FOOD | DIY | AUTOMOTIVE | TEXTILES

LUTZ allows access to all its website content for viewing purposes. Copying and reproducing content (copy, images etc.) for anything more than transient use is not permitted. This content may not be modified or used on other websites or networked computers without prior written approval by LUTZ GmbH & Co. KG.

Copyright: © COPYRIGHT LUTZ GmbH & Co. KG, Solingen, Germany. All rights reserved. Copy, photos, graphics, technical drawings, layouts and other information used in all our publications and their arrangements on our LUTZ website are subject to copyright and other proprietary rights.

Proprietary rights: The owner of the brandnames used by LUTZ is LUTZ GmbH & Co. KG, Solingen, Germany (unless otherwise stated). Third Parties are explicitly prohibited from using any of the brandnames, logos or marks of any kind found there. This applies in particular to the internationally registered trademarks of LUTZ, which consist of the letters 'LUTZ' and 'exactly', all violations against trademark law regarding its trademarks.

E & OE. Brandnames marked with an asterisk (*) are not owned by LUTZ GmbH & Co. KG. Subject to our general terms & conditions on the Internet at www.lutz-blades.com.

Ref.	Length (mm)	Width (mm)	Thickn. (mm)
6030.0254	38.0	8.0	0.25
0707.0380	57.0	19.1	0.38
0710.0400	57.7	18.8	0.40
0697.0400	28.5	19.1	0.40
4307.1000	57.7	19.1	1.00
0711.0430	57.0	19.1	0.43
0713.0630	57.2	19.1	0.63
0709.0380	57.0	18.8	0.38
0730.1000	57.7	19.1	1.00

Ref.	Length (mm)	Width (mm)	Thickn. (mm)
0700.0400	59.0	18.8	0.40
0698.0400	59.0	18.8	0.40
0703.0380	57.0	19.1	0.38
0705.0400		18.8	0.40
0714.0500			0.50
0715.0900	59.0		0.90
0729.0630	57.0	19.1	0.60
0717.0630	57.2	19.1	0.63
0724.0300	45.0	18.8	0.30
0718.0400			0.40

Ref.	Length (mm)	Width (mm)	Thickn. (mm)
2650.0530	41.4	63.8	0.53
2651.0530	40.9	63.0	0.53
0308.0228	39.8	19.5	0.23
0300.0250	40.0	19.9	0.25

LUTZ - CIRCULAR BLADES AND CUTTERS

Thanks to their razor-sharp cutting edges, their excellent flatness and hardening, our circular blades and cutters have been acknowledged for years as being among the best.

Something we keep working on every day! To keep your production rolling.



CUSTOM BLADES | FILM AND FOIL | CHEMICAL FIBRES AND FIBREGLASS | MEDICAL | FOOD | DIY | AUTOMOTIVE | TEXTILES

LUTZ allows access to all its website content for viewing purposes. Copying and reproducing content (copy, images etc.) for anything more than transient use is not permitted. This content may not be modified or used on other websites or networked computers without prior written approval by LUTZ GmbH & Co. KG.

Copyright: © COPYRIGHT LUTZ GmbH & Co. KG, Solingen, Germany. All rights reserved. Copy, photos, graphics, technical drawings, layouts and other information used in all our publications and their arrangements on our LUTZ website are subject to copyright and other proprietary rights.

Proprietary rights: The owner of the brandnames used by LUTZ is LUTZ GmbH & Co. KG, Solingen, Germany (unless otherwise stated). Third Parties are explicitly prohibited from using any of the brandnames, logos or marks of any kind found there. This applies in particular to the internationally registered trademarks of LUTZ, as well as to all violations against trademark law regarding its trademarks.

E & OE. Brandnames marked with an asterisk (*) are not owned by LUTZ GmbH & Co. KG. Subject to our general terms & conditions on the Internet at www.lutz-blades.com.

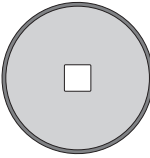
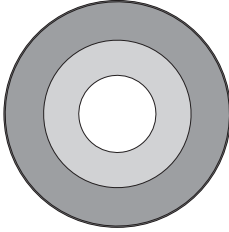
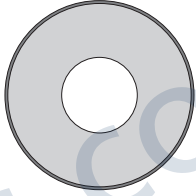
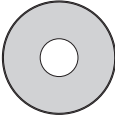
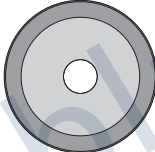
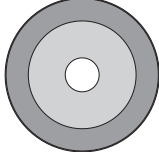
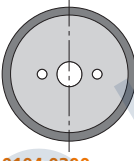
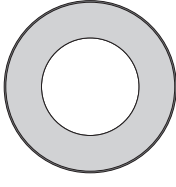
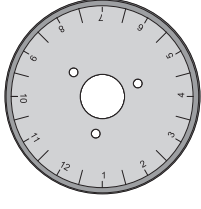
Ref.	ø OD (mm)	ø ID (mm)	Thickn. (mm)	Ref.	ø OD (mm)	ø ID (mm)	Thickn. (mm)	Ref.	ø OD (mm)	ø ID (mm)	Thickn. (mm)
	40.0	7.0	0.30		100.0	34.0	1.00		50.0	20.0	0.20
0108.0300				0125.1000				0145.0200			
0114.0300	26.0										
	30.0	10.0	0.10		45.0	10.0	0.50		100.0	22.0	1.00
0129.0100				0119.0500				0115.1000			
	30.0	5.0	0.30		30.0	17.0	0.10		44.0	10.0	0.30
0104.0300				0120.0100	50.0	25.0	0.15	0159.0300			
				0126.0150	70.0	48.0	0.15				
				0175.0150							

BLADES IN CUTTING MACHINES? THAT MAKES US PARTNERS.

We provide replacement blades for the following makes of machines:

- » Windmüller & Hölscher[®]
- » Reifenhäuser[®]
- » Starlinger[®]
- » Kampf[®]
- » Barmag[®]
- » Brückner[®]
- » SML/Lenzing[®]
- » Atlas[®]
- » Goebel[®]
- ... and more









CUSTOM BLADES | FILM AND FOIL | CHEMICAL FIBRES AND FIBREGLASS | MEDICAL | FOOD | DIY | AUTOMOTIVE | TEXTILES

LUTZ allows access to all its website content for viewing purposes. Copying and reproducing content (copy, images etc.) for anything more than transient use is not permitted. This content may not be modified or used on other websites or networked computers without prior written approval by LUTZ GmbH & Co. KG.

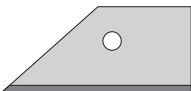
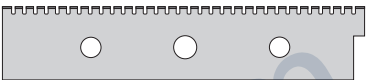
Copyright: © COPYRIGHT LUTZ GmbH & Co. KG, Solingen, Germany. All rights reserved. Copy, photos, graphics, technical drawings, layouts and other information used in all our publications and their arrangements on our LUTZ website are subject to copyright and other proprietary rights.

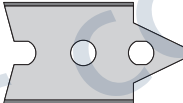
Proprietary rights: The owner of the brandnames used by LUTZ is LUTZ GmbH & Co. KG, Solingen, Germany (unless otherwise stated). Third Parties are explicitly prohibited from using any of the brandnames, logos or marks of any kind found there. This applies in particular to the internationally registered trademarks, symbols, LUTZ logos, which consist of words, letters, numbers, figures, lines, colors, or other elements against trademark law regarding its trademarks.

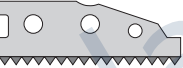
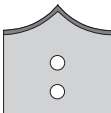
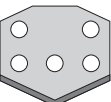
E & OE. Brandnames marked with an asterisk (*) are not owned by LUTZ GmbH & Co. KG. Subject to our general terms & conditions on the Internet at www.lutz-blades.com.

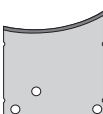
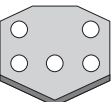
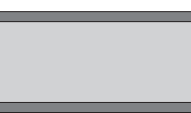
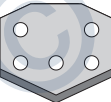
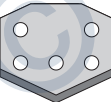
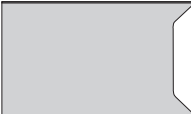
Ref.	Length (mm)	Width (mm)	Thickn. (mm)	Ref.	Length (mm)	Width (mm)	Thickn. (mm)	Ref.	Length (mm)	Width (mm)	Thickn. (mm)
 0021.0400	21.0	8.0	0.40	 1052.0680	42.4	19.0	0.68	 0840.0300	99.0	20.0	0.30
 0023.0500	14.0	12.0	0.50	 0918.0800	65.0	19.0	0.80	 0220.0300	39.5	22.2	0.30
 0016.0500	19.0	16.9	0.50	 4011.0880	40.0	14.0	0.88	 1240.0380	24.0	25.4	0.38
 0010.0400	23.0	21.0	0.40	 0801.0300	43.0	22.2	0.30	 1350.0400	24.3	22.0	0.40
 0014.0500	23.0	21.0	0.50	 0802.0400	43.0	22.2	0.40				
 0012.0500	23.8	21.0	0.50								
 0013.0200	23.8	21.0	0.20								
 0441.0150	43.0	22.2	0.15								

LUTZ MANUFACTURES OVER 500 DIFFERENT CUSTOM BLADES TO CUSTOMERS' DRAWINGS

Our product range consists of serrated, toothed, wavy, curved, notched, pointed, multi-sided, crimped special-purpose blades or combinations of several shapes and geometries.

Thanks to rapid prototyping and our highly flexible manufacturing technologies we are in a position to manufacture small (and even very small) runs of custom blades in only a few days!













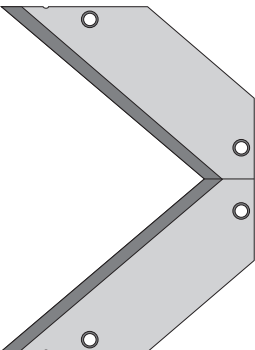
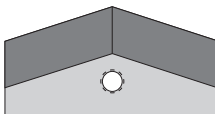

CUSTOM BLADES | FILM AND FOIL | CHEMICAL FIBRES AND FIBREGLASS | MEDICAL | FOOD | DIY | AUTOMOTIVE | TEXTILES

LUTZ allows access to all its website content for viewing purposes. Copying and reproducing content (copy, images etc.) for anything more than transient use is not permitted. This content may not be modified or used on other websites or networked computers without prior written approval by LUTZ GmbH & Co. KG.

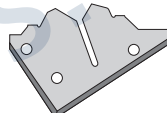
Copyright: © COPYRIGHT LUTZ GmbH & Co. KG, Solingen, Germany. All rights reserved. Copy, photos, graphics, technical drawings, layouts and other information used in all our publications and their arrangements on our LUTZ website are subject to copyright and other proprietary rights.

Proprietary rights: The owner of the brandnames used by LUTZ is LUTZ GmbH & Co. KG, Solingen, Germany (unless otherwise stated). Third Parties are explicitly prohibited from using any of the brandnames, logos or marks of any kind found there. This applies in particular to the internationally registered trademarks, symbols, LUTZ logos, which are subject to trademark law regarding its trademarks.

E & OE. Brandnames marked with an asterisk (*) are not owned by LUTZ GmbH & Co. KG. Subject to our general terms & conditions on the Internet at www.lutz-blades.com.

Ref.	Length (mm)	Width (mm)	Thickn. (mm)	Ref.	Length (mm)	Width (mm)	Thickn. (mm)	Ref.	Length (mm)	Width (mm)	Thickn. (mm)
	92.0	67.9	0.50		50.0	25.0	2.00		21.5	11.5	0.70
2802.0500				0027.2000				0015.0700			
	29.0	5.0	0.40		12.0	4.1	0.40		41.0	5.6	0.50
6435.0400				0019.0400				0026.0500			
	90.0	14.0	2.50		50.0	20.0	0.40		32.0	32.0	0.70
9530.2500				9605.0400				4440.0700			
	18.8	4.8	0.50		7.0	7.0	0.68		23.0	15.6	0.65
3290.0500				0045.0680				9810.0650			
					10.3	12.0	1.20				
				0076.1200							
	413.0	40.0	1.00								
9590.1000											

LUTZ INDUSTRIAL BLADES HAVE THE FOLLOWING CHARACTERISTICS

- » The best materials
- » Adherence to the closest tolerances
- » Optimum hardness
- » Selected high-performance coatings













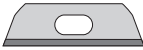

CUSTOM BLADES | FILM AND FOIL | CHEMICAL FIBRES AND FIBREGLASS | MEDICAL | FOOD | DIY | AUTOMOTIVE | TEXTILES

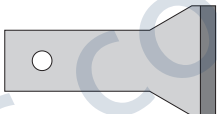
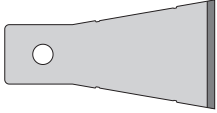
LUTZ allows access to all its website content for viewing purposes. Copying and reproducing content (copy, images etc.) for anything more than transient use is not permitted. This content may not be modified or used on other websites or networked computers without prior written approval by LUTZ GmbH & Co. KG.

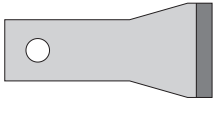
Copyright: © COPYRIGHT LUTZ GmbH & Co. KG, Solingen, Germany. All rights reserved. Copy, photos, graphics, technical drawings, layouts and other information used in all our publications and their arrangements on our LUTZ website are subject to copyright and other proprietary rights.

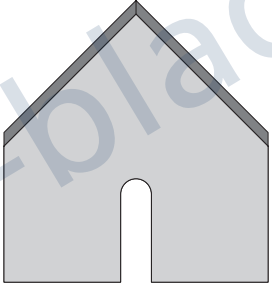
Proprietary rights: The owner of the brandnames used by LUTZ is LUTZ GmbH & Co. KG, Solingen, Germany (unless otherwise stated). Third Parties are explicitly prohibited from using any of the brandnames, logos or marks of any kind found there. This applies in particular to the internationally registered trademark symbols LUTZ, which are subject to the laws of trademark law regarding its trademarks.

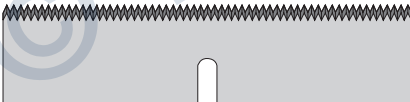
E & OE. Brandnames marked with an asterisk (*) are not owned by LUTZ GmbH & Co. KG. Subject to our general terms & conditions on the Internet at www.lutz-blades.com.

Ref.	Length (mm)	Width (mm)	Thickn. (mm)	Ref.	Length (mm)	Width (mm)	Thickn. (mm)	Ref.	Length (mm)	Width (mm)	Thickn. (mm)
	31.0	9.0	0.60		33.3	7.8	0.30		14.0	12.9	0.40
	250.0	28.0	1.00		46.0	24.0	0.80		46.5	24.2	1.00
	112.0	19.0	0.38		44.0	20.0	0.80		46.0	13.2	1.00
			0.40		60.0	64.0	1.20				
	40.5	8.2	0.40								
	108.0	25.4	0.51								
	499.0	20.0	1.00								

CHOICE OF MATERIAL

Our range of products covers blades of between 0.06 and 3.0 mm in thickness and with final hardness ratings of 40 - 85 HRc.

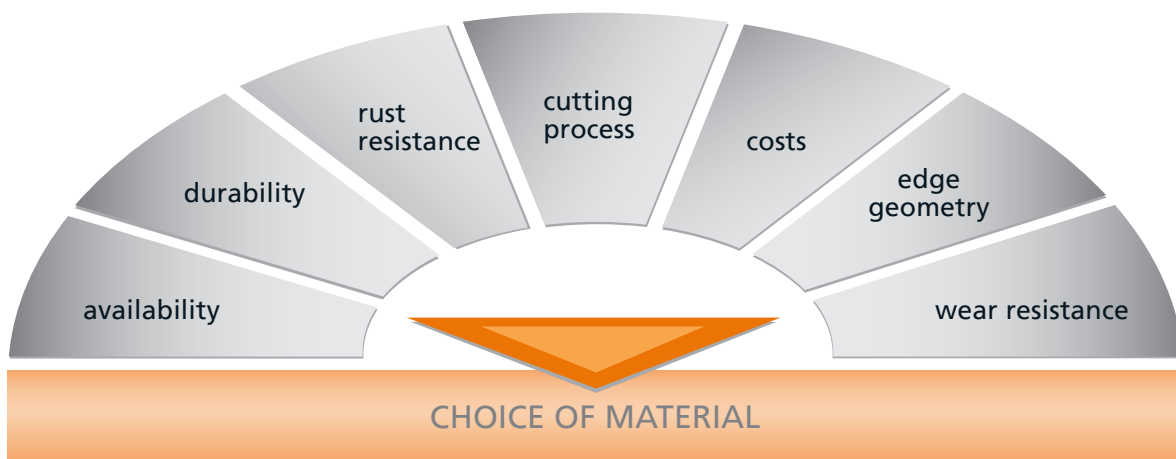

- Our range of materials includes:
- » Carbon steels
 - » Stainless and rust-resistant steels
 - » Highspeed steels (HSS)
 - » Tool steels
 - » Tungsten carbides
 - » Ceramics

LUTZ allows access to all its website content for viewing purposes. Copying and reproducing content (copy, images etc.) for anything more than transient use is not permitted. This content may not be modified or used on other websites or networked computers without prior written approval by LUTZ GmbH & Co. KG.

Copyright: © COPYRIGHT LUTZ GmbH & Co. KG, Solingen, Germany. All rights reserved. Copy, photos, graphics, technical drawings, layouts and other information used in all our publications and their arrangements on our LUTZ website are subject to copyright and other proprietary rights.

Proprietary rights: The owner of the brandnames used by LUTZ is LUTZ GmbH & Co. KG, Solingen, Germany (unless otherwise stated). Third Parties are explicitly prohibited from using any of the brandnames, logos or marks of any kind found there. This applies in particular to the internationally registered trademark symbols LUTZ, which are the basis of our trademark law regarding its trademarks.

E & OE. Brandnames marked with an asterisk (*) are not owned by LUTZ GmbH & Co. KG. Subject to our general terms & conditions on the Internet at www.lutz-blades.com.

CUTTING EDGE SHAPES

For the definition of edge type and bevel configuration see the following matrix:



LUTZ allows access to all its website content for viewing purposes. Copying and reproducing content (copy, images etc.) for anything more than transient use is not permitted. This content may not be modified or used on other websites or networked computers without prior written approval by LUTZ GmbH & Co. KG.

Copyright: © COPYRIGHT LUTZ GmbH & Co. KG, Solingen, Germany. All rights reserved. Copy, photos, graphics, technical drawings, layouts and other information used in all our publications and their arrangements on our LUTZ website are subject to copyright and other proprietary rights.

Proprietary rights: The owner of the brandnames used by LUTZ is LUTZ GmbH & Co. KG, Solingen, Germany (unless otherwise stated). Third Parties are explicitly prohibited from using any of the brandnames, logos or marks of any kind found there. This applies in particular to the internationally registered trademarks, logos or marks of any kind which are used in the design of LUTZ products, which are subject to trademark law regarding its trademarks.

E & OE. Brandnames marked with an asterisk (*) are not owned by LUTZ GmbH & Co. KG. Subject to our general terms & conditions on the Internet at www.lutz-blades.com.

		single edged	double edged	convex	concave
one sided					
		a	g	m	t
		b	h	n	u
two sided		c	i	o	v
		d	j	p	w
		e	k	r	x
		f	l	s	y

COATINGS

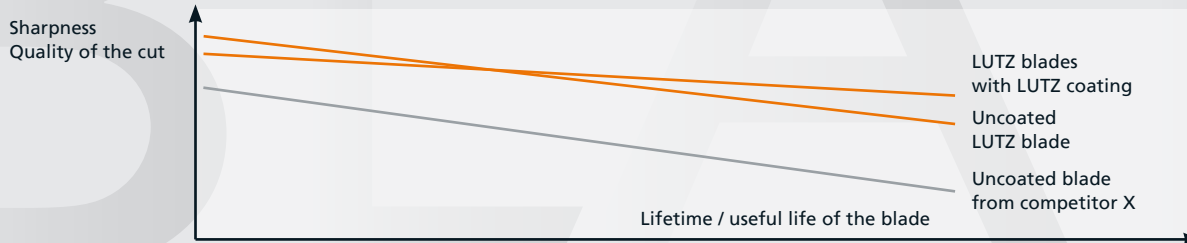

LUTZ allows access to all its website content for viewing purposes. Copying and reproducing content (copy, images etc.) for anything more than transient use is not permitted. This content may not be modified or used on other websites or networked computers without prior written approval by LUTZ GmbH & Co. KG.

Copyright: © COPYRIGHT LUTZ GmbH & Co. KG, Solingen, Germany. All rights reserved. Copy, photos, graphics, technical drawings, layouts and other information used in all our publications and their arrangements on our LUTZ website are subject to copyright and other proprietary rights.

Proprietary rights: The owner of the brandnames used by LUTZ is LUTZ GmbH & Co. KG, Solingen, Germany (unless otherwise stated). Third Parties are explicitly prohibited from using any of the brandnames, logos or marks of any kind found there. This applies in particular to the internationally registered trademark symbols LUTZ, exactly, which consist of the letters LUTZ, exactly, and all violations against trademark law regarding its trademarks.

E & OE. Brandnames marked with an asterisk (*) are not owned by LUTZ GmbH & Co. KG. Subject to our general terms & conditions on the Internet at www.lutz-blades.com.

The LUTZ coatings range includes the following choices:

TiN

Standard hard coating with tough resistance to wear with a relatively high coefficient of friction (compared with steel as a reference material: 0.4 to 0.7), usually gold coloured, safe use at up to approx. 300 °C.

TiC

Has lower resistance to wear than TiN and a considerably lower coefficient of friction (compared with steel as a reference material: 0.3 to 0.5), usually charcoal grey.

TiCN

Takes a position between the high wear resistance of TiN and the low coefficient of friction of TiC, relative position between TiN and TiC depending on C and N content, usually charcoal grey.

TiAlN

Has greater resistance to oxidation than TiN with a comparable coefficient of friction, usually charcoal grey.

ZrN

With wear resistance similar to TiN, but with a more dense morphology than TiN and, as a result, more resistant to pitting under comparable load, usually steel colour.

CrN

Lower wear resistance than TiN. The advantage of CrN is it has a lower inherent tension than TiN. As a result, can be used for applications with high bending loads.

DLC

Has a high wear resistance and a low coefficient of friction (approx. 0.4 compared with steel as a reference); sensitive to impacts and high temperatures (between 100° and 300 °C depending on structure).

Teflon® (PTFE)

Non-stick coating Teflon® (PTFE), very low static friction allows a smooth cut, therefore a popular coating for medical devices. Because of the low surface tension almost no contamination from the cut goods. Acid and base-resistant, not suitable in combination with Na (sodium). Temperature resistant up to 250°C (480°F). Medium wear resistance.

Coloured lacquer

Applied to entire surface, acts as an aid to sorting different material thicknesses and as anticorrosion protection.

Bluing and blackening

Applied to entire surface, some anticorrosion protection and thickness protection, also aids differentiation.